

BLF888

UHF power LDMOS transistor

Rev. 5 — 21 January 2011

Product data sheet

1. Product profile

1.1 General description

A 500 W LDMOS RF power transistor for broadcast transmitter applications and industrial applications. The transistor is optimized for digital applications and can deliver 110 W average DVB-T broadband over the full UHF band from 470 MHz to 860 MHz. The excellent ruggedness of this device makes it ideal for digital transmitter applications.

Table 1. Application information

RF performance at $V_{DS} = 50$ V in a common source 860 MHz narrowband test circuit unless otherwise specified.

Mode of operation	f (MHz)	$P_{L(PEP)}$ (W)	$P_{L(AV)}$ (W)	G_p (dB)	η_D (%)	IMD3 (dBc)	IMD _{shldr} (dBc)
2-Tone, class AB	$f_1 = 860; f_2 = 860.1$	500	250	19	46	-32	-
DVB-T (8k OFDM)	858	-	110	19	31	-	-31 [1]

[1] Measured [dBc] with delta marker at 4.3 MHz from center frequency.

CAUTION



This device is sensitive to ElectroStatic Discharge (ESD). Therefore care should be taken during transport and handling.

1.2 Features and benefits

- 2-Tone performance at 860 MHz, a drain-source voltage V_{DS} of 50 V and a quiescent drain current $I_{Dq} = 1.3$ A:
 - ◆ Peak envelope power load power = 500 W
 - ◆ Power gain = 19 dB
 - ◆ Drain efficiency = 46 %
 - ◆ Third order intermodulation distortion = -32 dBc
- DVB performance at 858 MHz, a drain-source voltage V_{DS} of 50 V and a quiescent drain current $I_{Dq} = 1.3$ A:
 - ◆ Average output power = 110 W
 - ◆ Power gain = 19 dB
 - ◆ Drain efficiency = 31 %
 - ◆ Shoulder distance = -31 dBc (4.3 MHz from center frequency)
- Integrated ESD protection
- Advanced flange material for optimum thermal behavior and reliability



- Excellent ruggedness
- High power gain
- High efficiency
- Designed for broadband operation (470 MHz to 860 MHz)
- Excellent reliability
- Internal input matching for high gain and optimum broadband operation
- Easy power control
- Compliant to Directive 2002/95/EC, regarding Restriction of Hazardous Substances (RoHS)

1.3 Applications

- Communication transmitter applications in the UHF band
- Industrial applications in the UHF band

2. Pinning information

Table 2. Pinning

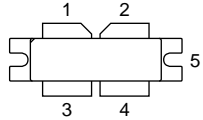
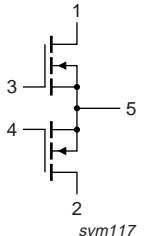
Pin	Description	Simplified outline	Graphic symbol
1	drain1		 <p style="text-align: right; margin-right: 50px;">sym117</p>
2	drain2		
3	gate1		
4	gate2		
5	source [1]		

[1] Connected to flange.

3. Ordering information

Table 3. Ordering information

Type number	Package		
	Name	Description	Version
BLF888	-	flanged LDMOST ceramic package; 2 mounting holes; 4 leads	SOT979A

4. Limiting values

Table 4. Limiting values

In accordance with the Absolute Maximum Rating System (IEC 60134).

Symbol	Parameter	Conditions	Min	Max	Unit
V_{DS}	drain-source voltage		-	104	V
V_{GS}	gate-source voltage		-0.5	+11	V
T_{stg}	storage temperature		-65	+150	°C
T_j	junction temperature		-	200	°C

5. Thermal characteristics

Table 5. Thermal characteristics

Symbol	Parameter	Conditions	Typ	Unit
$R_{th(j-c)}$	thermal resistance from junction to case	$T_{case} = 80\text{ °C}$; $P_{L(AV)} = 110\text{ W}$	[1]	0.24 K/W

[1] $R_{th(j-c)}$ is measured under RF conditions.

6. Characteristics

Table 6. DC characteristics

$T_j = 25\text{ °C}$ unless otherwise specified.

Symbol	Parameter	Conditions	Min	Typ	Max	Unit
$V_{(BR)DSS}$	drain-source breakdown voltage	$V_{GS} = 0\text{ V}$; $I_D = 2.7\text{ mA}$	[1]	104	-	V
$V_{GS(th)}$	gate-source threshold voltage	$V_{DS} = 10\text{ V}$; $I_D = 270\text{ mA}$	[1]	1.4	1.9	2.4 V
I_{DSS}	drain leakage current	$V_{GS} = 0\text{ V}$; $V_{DS} = 50\text{ V}$	-	-	2.8	μA
I_{DSX}	drain cut-off current	$V_{GS} = V_{GS(th)} + 3.75\text{ V}$; $V_{DS} = 10\text{ V}$	-	43	-	A
I_{GSS}	gate leakage current	$V_{GS} = 10\text{ V}$; $V_{DS} = 0\text{ V}$	-	-	280	nA
g_{fs}	forward transconductance	$V_{DS} = 10\text{ V}$; $I_D = 13.5\text{ A}$	[1]	-	17	S
$R_{DS(on)}$	drain-source on-state resistance	$V_{GS} = V_{GS(th)} + 3.75\text{ V}$; $I_D = 9.5\text{ A}$	[1]	-	105	$\text{m}\Omega$
C_{iss}	input capacitance	$V_{GS} = 0\text{ V}$; $V_{DS} = 50\text{ V}$; $f = 1\text{ MHz}$	[2]	-	205	pF
C_{oss}	output capacitance	$V_{GS} = 0\text{ V}$; $V_{DS} = 50\text{ V}$; $f = 1\text{ MHz}$	[2]	-	65	pF
C_{rss}	reverse transfer capacitance	$V_{GS} = 0\text{ V}$; $V_{DS} = 50\text{ V}$; $f = 1\text{ MHz}$	[2]	-	2.2	pF

[1] I_D is the drain current.

[2] Capacitance values without internal matching.

Table 7. RF characteristics

$T_h = 25\text{ °C}$ unless otherwise specified.

Symbol	Parameter	Conditions	Min	Typ	Max	Unit
2-Tone, class AB						
V_{DS}	drain-source voltage		-	50	-	V
I_{Dq}	quiescent drain current	total device	-	1.3	-	A
$P_{L(PEP)}$	peak envelope power load power		500	-	-	W
$P_{L(AV)}$	average output power		250	-	-	W
G_p	power gain		18	19	-	dB
η_D	drain efficiency		42	46	-	%
IMD3	third-order intermodulation distortion		-	-32	-28	dBc
DVB-T (8k OFDM)						
V_{DS}	drain-source voltage		-	50	-	V
I_{Dq}	quiescent drain current	total device	-	1.3	-	A
$P_{L(AV)}$	average output power		110	-	-	W
G_p	power gain		18	19	-	dB

Table 7. RF characteristics ...continued
 $T_h = 25\text{ }^\circ\text{C}$ unless otherwise specified.

Symbol	Parameter	Conditions	Min	Typ	Max	Unit
η_D	drain efficiency		28	31	-	%
IMD_{shldr}	intermodulation distortion shoulder		[1]	-31	-28	dBc
PAR	peak-to-average ratio		[2]	8.3	-	dB

- [1] Measured [dBc] with delta marker at 4.3 MHz from center frequency.
- [2] PAR (of output signal) at 0.01 % probability on CCDF; PAR of input signal = 9.5 dB at 0.01 % probability on CCDF.

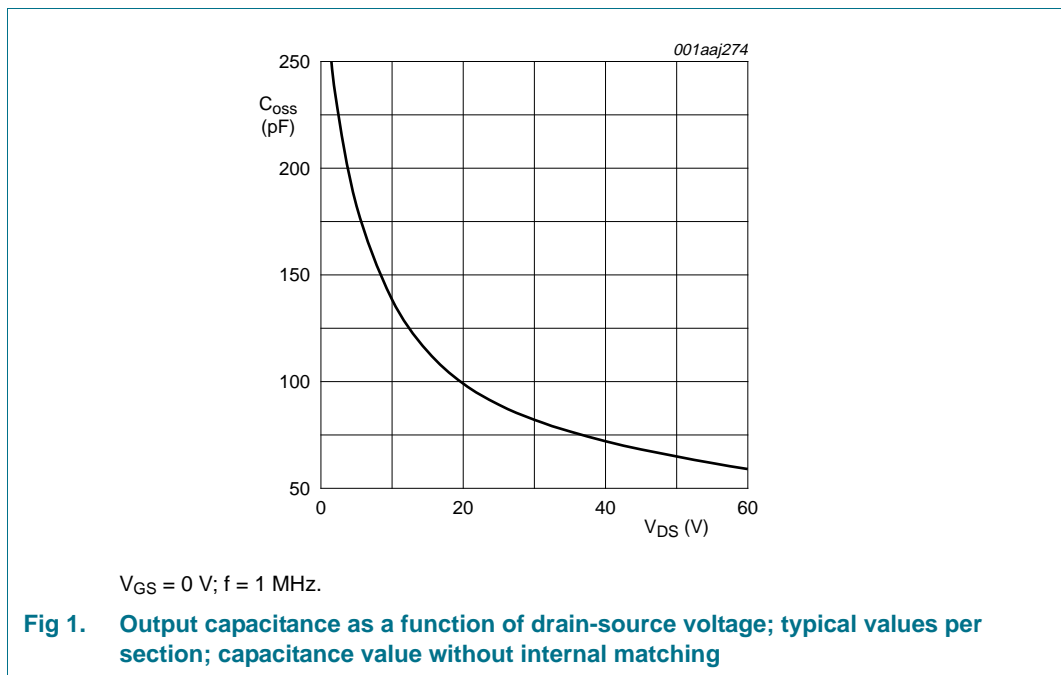

6.1 Ruggedness in class-AB operation

The BLF888 is capable of withstanding a load mismatch corresponding to $V_{SWR} = 10 : 1$ through all phases under the following conditions: $V_{DS} = 50\text{ V}$; $f = 860\text{ MHz}$ at rated power. Ruggedness is measured in the application circuit as described in [Section 8](#).

7. Application information

7.1 Narrowband RF figures

7.1.1 2-Tone

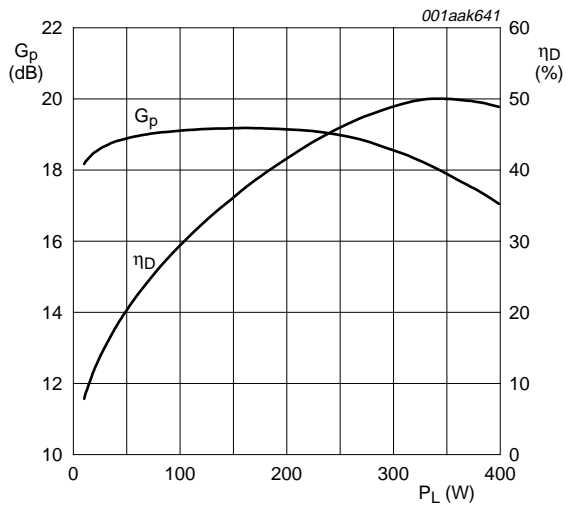

$V_{DS} = 50\text{ V}$; $I_{DQ} = 1.3\text{ A}$; measured in a common source narrowband 860 MHz test circuit.

Fig. 2. 2-Tone power gain and drain efficiency as function of load power; typical values

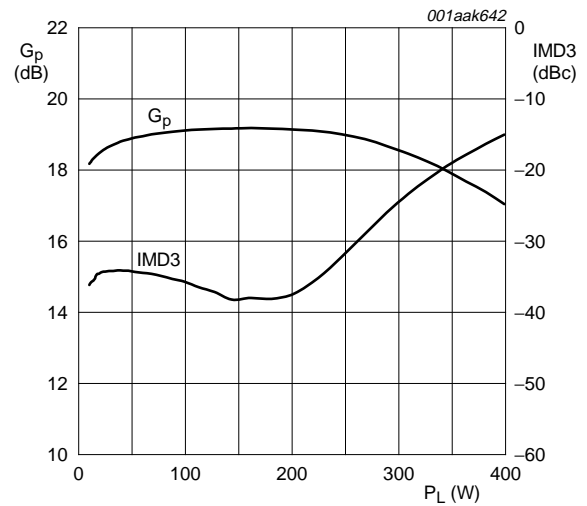

$V_{DS} = 50\text{ V}$; $I_{DQ} = 1.3\text{ A}$; measured in a common source narrowband 860 MHz test circuit.

Fig. 3. 2-Tone power gain and third order intermodulation distortion as function of load power; typical values

7.1.2 DVB-T

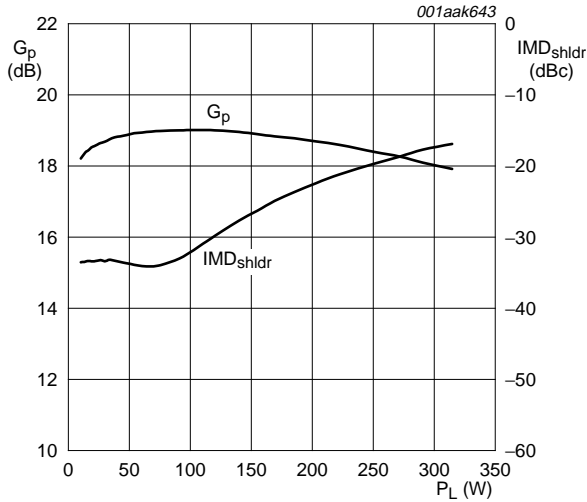

$V_{DS} = 50$ V; $I_{Dq} = 1.3$ A; measured in a common source narrowband 860 MHz test circuit.

Fig 4. DVB-T power gain and intermodulation distortion shoulder as function of load power; typical values

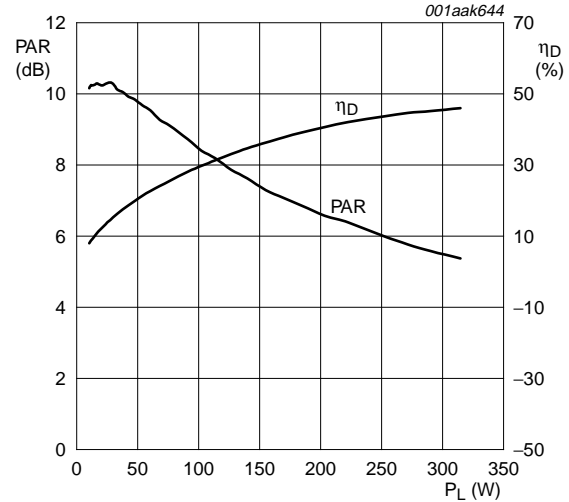

$V_{DS} = 50$ V; $I_{Dq} = 1.3$ A; measured in a common source narrowband 860 MHz test circuit.

Fig 5. DVB-T peak-to-average ratio and drain efficiency as function of load power; typical values

7.2 Broadband RF figures

7.2.1 2-Tone

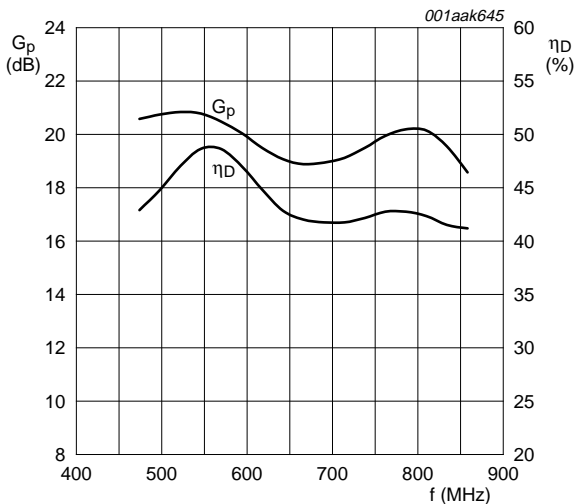

$P_{L(AV)} = 250$ W; $V_{DS} = 50$ V; $I_{Dq} = 1.3$ A; measured in a common source broadband test circuit as described in Section 8.

Fig 6. 2-Tone power gain and drain efficiency as function of frequency; typical values

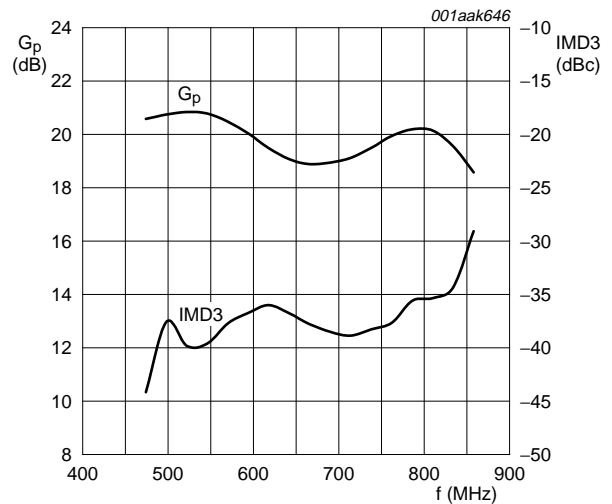

$P_{L(AV)} = 250$ W; $V_{DS} = 50$ V; $I_{Dq} = 1.3$ A; measured in a common source broadband test circuit as described in Section 8.

Fig 7. 2-Tone power gain and third order intermodulation distortion as function of frequency; typical values

7.2.2 DVB-T

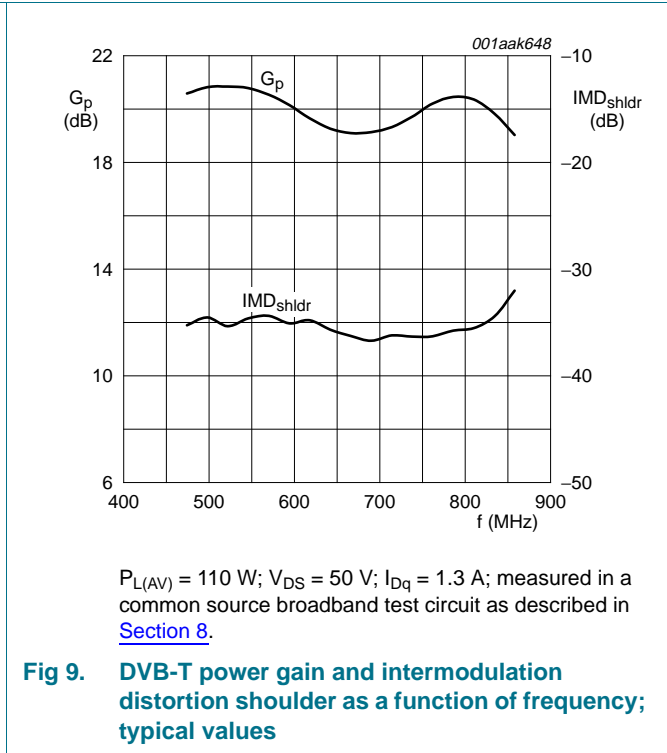
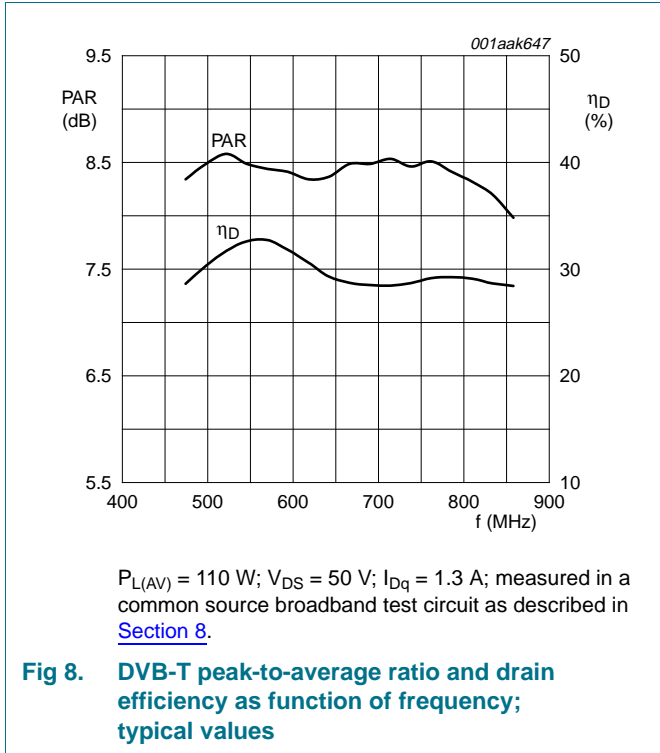

7.3 Impedance information

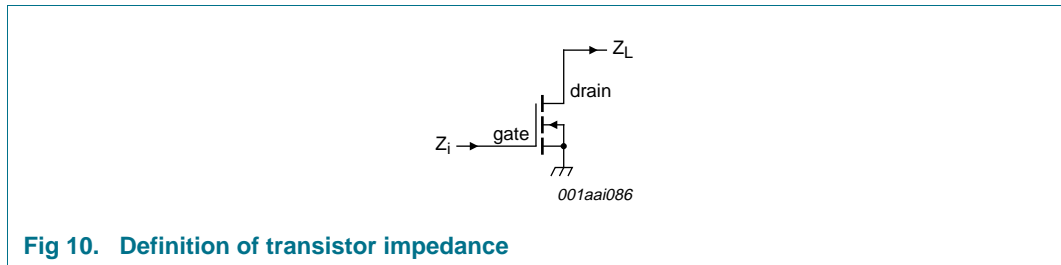

Table 8. Typical push-pull impedance

Simulated Z_i and Z_L device impedance; impedance info at $V_{DS} = 50\text{ V}$ and $P_{L(PEP)} = 600\text{ W}$ (DVB-T).

f MHz	Z_i Ω	Z_L Ω
300	1.018 - j1.350	5.565 + j0.747
325	1.045 - j1.022	5.435 + j0.752
350	1.076 - j0.722	5.303 + j0.746
375	1.110 - j0.444	5.167 + j0.730
400	1.148 - j0.183	5.030 + j0.704
425	1.190 + j0.064	4.892 + j0.668
450	1.238 + j0.299	4.754 + j0.622
475	1.291 + j0.526	4.617 + j0.567
500	1.351 + j0.746	4.481 + j0.504

Table 8. Typical push-pull impedance ...continuedSimulated Z_i and Z_L device impedance; impedance info at $V_{DS} = 50$ V and $P_{L(PEP)} = 600$ W (DVB-T).

f MHz	Z_i Ω	Z_L Ω
525	1.417 + j0.961	4.346 + j0.432
550	1.492 + j1.171	4.214 + j0.353
575	1.577 + j1.378	4.084 + j0.266
600	1.672 + j1.582	3.958 + j0.173
625	1.779 + j1.783	3.834 + j0.074
650	1.901 + j1.983	3.713 - j0.031
675	2.039 + j2.180	3.596 - j0.142
700	2.196 + j2.373	3.482 - j0.257
725	2.376 + j2.563	3.372 - j0.377
750	2.581 + j2.745	3.266 - j0.501
775	2.817 + j2.918	3.163 - j0.628
800	3.087 + j3.076	3.064 - j0.759
825	3.395 + j3.212	2.968 - j0.893
850	3.746 + j3.317	2.876 - j1.030
875	4.142 + j3.377	2.787 - j1.170
900	4.583 + j3.374	2.701 - j1.312
925	5.063 + j3.288	2.619 - j1.455
950	5.566 + j3.094	2.540 - j1.601
975	6.064 + j2.770	2.464 - j1.749
1000	6.514 + j2.299	2.391 - j1.898

7.4 Reliability

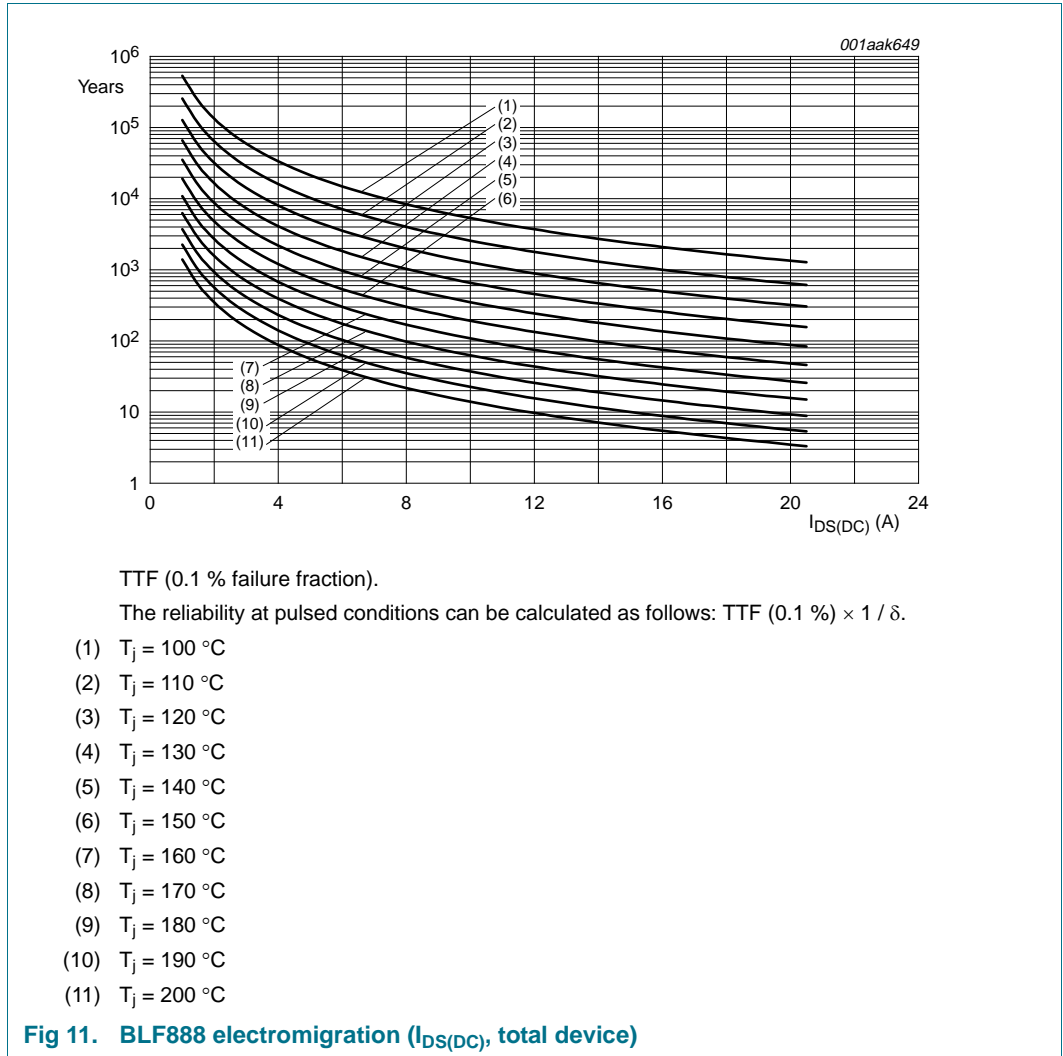

8. Test information

Table 9. List of components

For test circuit, see [Figure 12](#), [Figure 13](#) and [Figure 14](#).

Component	Description	Value	Remarks
B1, B2	semi rigid coax	25 Ω ; 49.5 mm	EZ90-25-TP
C1	multilayer ceramic chip capacitor	12 pF	[1]
C2, C9, C10	multilayer ceramic chip capacitor	10 pF	[1]
C3	multilayer ceramic chip capacitor	4.7 pF	[2]
C4, C5, C6	multilayer ceramic chip capacitor	8.2 pF	[1]
C7	multilayer ceramic chip capacitor	5.6 pF	[2]
C8, C13, C14	multilayer ceramic chip capacitor	100 pF	[1]
C11, C12	multilayer ceramic chip capacitor	2.0 pF	[2]

Table 9. List of components ...continued
For test circuit, see [Figure 12](#), [Figure 13](#) and [Figure 14](#).

Component	Description	Value	Remarks
C15, C16	multilayer ceramic chip capacitor	4.7 μ F, 50 V	TDK C4532X7R1E475MT020U or capacitor of same quality.
C17, C18	multilayer ceramic chip capacitor	100 pF	[2]
C19, C20	multilayer ceramic chip capacitor	10 μ F, 50 V	TDK C570X7R1H106KT000N or capacitor of same quality.
C21, C22	electrolytic capacitor	470 μ F; 63 V	
C30, C31	multilayer ceramic chip capacitor	10 pF	[3]
C32	multilayer ceramic chip capacitor	5.6 pF	[3]
C33, C34, C35	multilayer ceramic chip capacitor	100 pF	[3]
C36, C37	multilayer ceramic chip capacitor	4.7 μ F	TDK C4532X7R1E475MT020U or capacitor of same quality.
L1	microstrip	-	[4] (W \times L) 15 mm \times 13 mm
L2	microstrip	-	[4] (W \times L) 5 mm \times 26 mm
L3, L32	microstrip	-	[4] (W \times L) 2 mm \times 49.5 mm
L4	microstrip	-	[4] (W \times L) 1.7 mm \times 3.5 mm
L5	microstrip	-	[4] (W \times L) 2 mm \times 9.5 mm
L30	microstrip	-	[4] (W \times L) 5 mm \times 13 mm
L31	microstrip	-	[4] (W \times L) 2 mm \times 11 mm
L33	microstrip	-	[4] (W \times L) 2 mm \times 3 mm
R1, R2	resistor	10 Ω	
R3, R4	resistor	5.6 Ω	
R5, R6	resistor	100 Ω	
R7, R8	potentiometer	1 k Ω	

[1] American technical ceramics type 180R or capacitor of same quality.

[2] American technical ceramics type 100B or capacitor of same quality.

[3] American technical ceramics type 100A or capacitor of same quality.

[4] Printed-Circuit Board (PCB): Taconic RF35; $\epsilon_r = 3.5$ F/m; height = 0.76 mm; Cu (top/bottom metallization); thickness copper plating = 35 μ m.

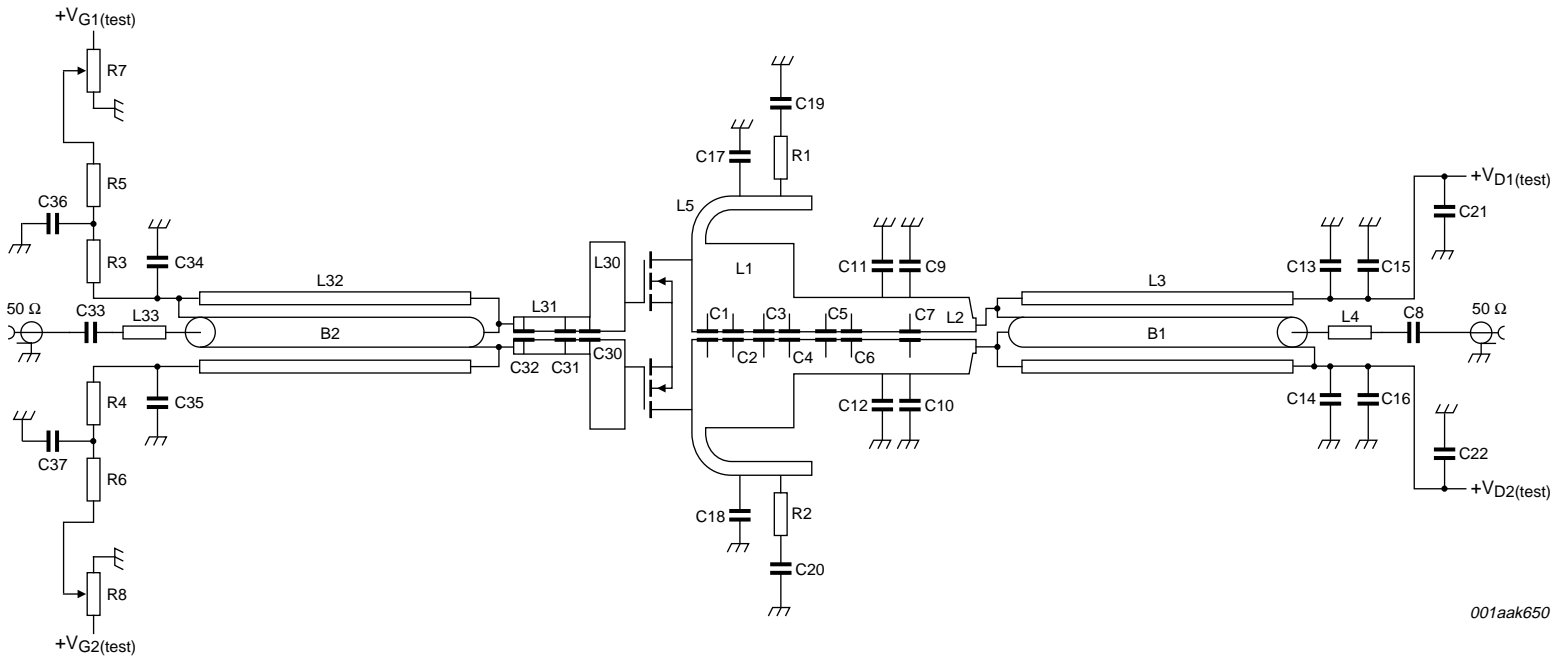

001aak650

See [Table 9](#) for a list of components.

Fig 12. Class-AB common-source broadband amplifier; $V_{D1(test)}$, $V_{D2(test)}$, $V_{G1(test)}$ and $V_{G2(test)}$ are drain and gate test voltages

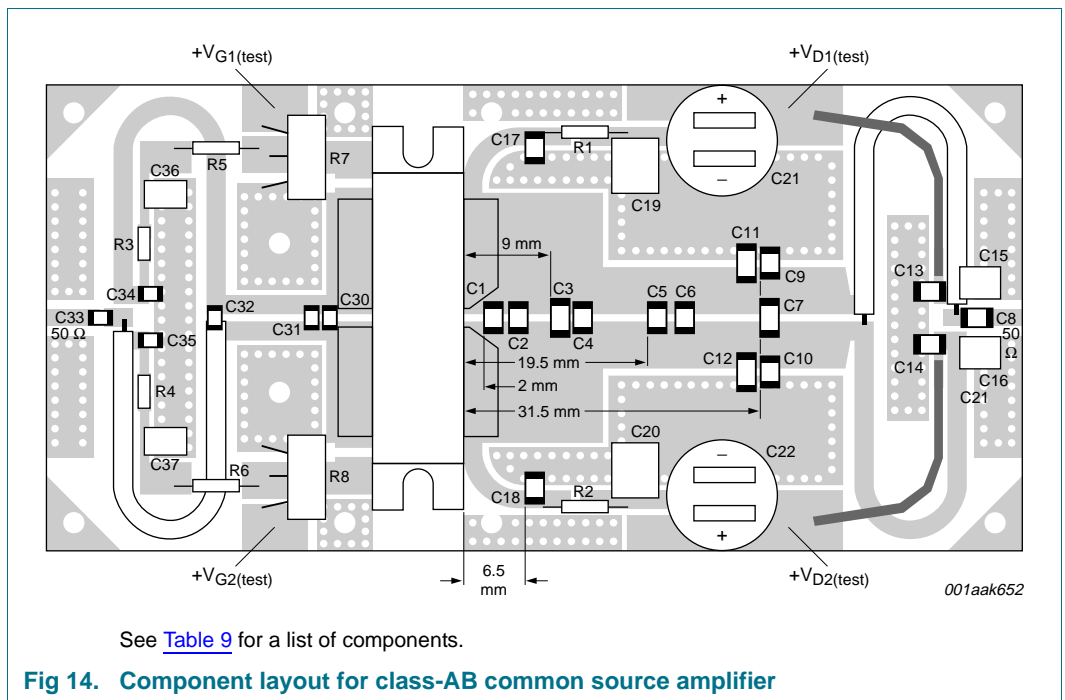
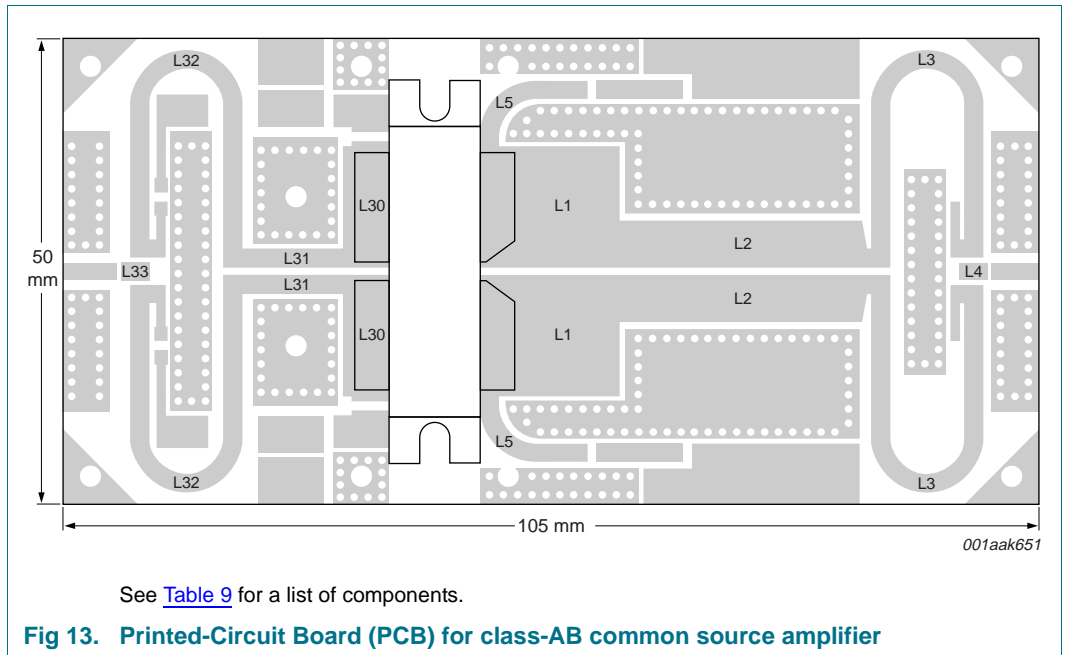

9. Package outline

Flanged LDMOST ceramic package; 2 mounting holes; 4 leads

SOT979A

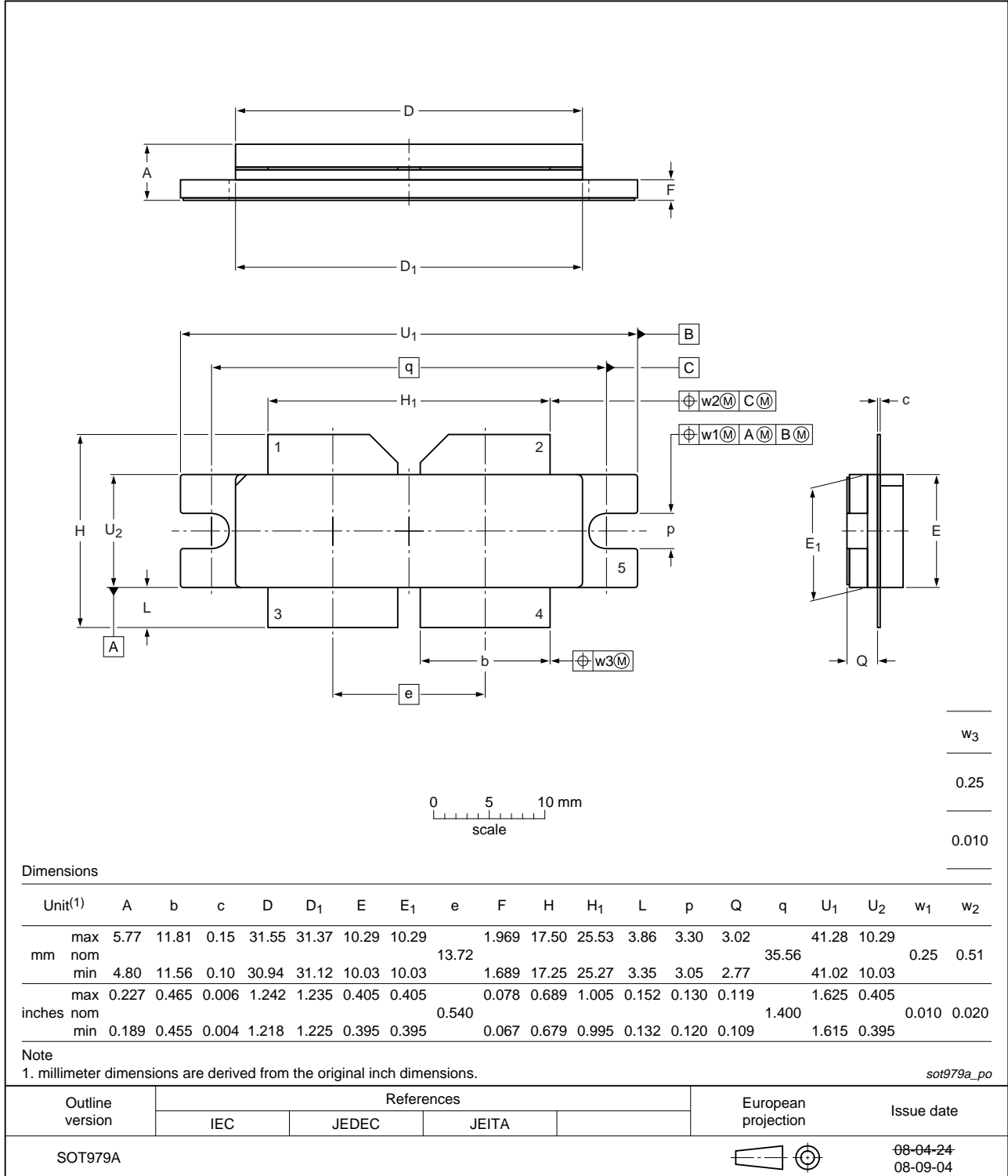

Fig 15. Package outline SOT979A

10. Abbreviations

Table 10. Abbreviations

Acronym	Description
CCDF	Complementary Cumulative Distribution Function
DVB	Digital Video Broadcast
DVB-T	Digital Video Broadcast - Terrestrial
LDMOS	Laterally Diffused Metal-Oxide Semiconductor
LDMOST	Laterally Diffused Metal-Oxide Semiconductor Transistor
OFDM	Orthogonal Frequency Division Multiplexing
PAR	Peak-to-Average power Ratio
RF	Radio Frequency
TTF	Time To Failure
UHF	Ultra High Frequency
VSWR	Voltage Standing-Wave Ratio

11. Revision history

Table 11. Revision history

Document ID	Release date	Data sheet status	Change notice	Supersedes
BLF888 v.5	20110121	Product data sheet	-	BLF888 v.4
Modifications:	<ul style="list-style-type: none"> • Table 6 on page 3: in the conditions column of g_{fs} the symbol V_{GS} has been changed to V_{DS}. 			
BLF888 v.4	20100429	Product data sheet	-	BLF888 v.3
BLF888 v.3	20100211	Product data sheet	-	BLF888 v.2
BLF888 v.2	20091022	Preliminary data sheet	-	BLF888 v.1
BLF888 v.1	20081216	Objective data sheet	-	-

12. Legal information

12.1 Data sheet status

Document status ^{[1][2]}	Product status ^[3]	Definition
Objective [short] data sheet	Development	This document contains data from the objective specification for product development.
Preliminary [short] data sheet	Qualification	This document contains data from the preliminary specification.
Product [short] data sheet	Production	This document contains the product specification.

[1] Please consult the most recently issued document before initiating or completing a design.

[2] The term 'short data sheet' is explained in section "Definitions".

[3] The product status of device(s) described in this document may have changed since this document was published and may differ in case of multiple devices. The latest product status information is available on the Internet at URL <http://www.nxp.com>.

12.2 Definitions

Draft — The document is a draft version only. The content is still under internal review and subject to formal approval, which may result in modifications or additions. NXP Semiconductors does not give any representations or warranties as to the accuracy or completeness of information included herein and shall have no liability for the consequences of use of such information.

Short data sheet — A short data sheet is an extract from a full data sheet with the same product type number(s) and title. A short data sheet is intended for quick reference only and should not be relied upon to contain detailed and full information. For detailed and full information see the relevant full data sheet, which is available on request via the local NXP Semiconductors sales office. In case of any inconsistency or conflict with the short data sheet, the full data sheet shall prevail.

Product specification — The information and data provided in a Product data sheet shall define the specification of the product as agreed between NXP Semiconductors and its customer, unless NXP Semiconductors and customer have explicitly agreed otherwise in writing. In no event however, shall an agreement be valid in which the NXP Semiconductors product is deemed to offer functions and qualities beyond those described in the Product data sheet.

12.3 Disclaimers

Limited warranty and liability — Information in this document is believed to be accurate and reliable. However, NXP Semiconductors does not give any representations or warranties, expressed or implied, as to the accuracy or completeness of such information and shall have no liability for the consequences of use of such information.

In no event shall NXP Semiconductors be liable for any indirect, incidental, punitive, special or consequential damages (including - without limitation - lost profits, lost savings, business interruption, costs related to the removal or replacement of any products or rework charges) whether or not such damages are based on tort (including negligence), warranty, breach of contract or any other legal theory.

Notwithstanding any damages that customer might incur for any reason whatsoever, NXP Semiconductors' aggregate and cumulative liability towards customer for the products described herein shall be limited in accordance with the *Terms and conditions of commercial sale* of NXP Semiconductors.

Right to make changes — NXP Semiconductors reserves the right to make changes to information published in this document, including without limitation specifications and product descriptions, at any time and without notice. This document supersedes and replaces all information supplied prior to the publication hereof.

Suitability for use — NXP Semiconductors products are not designed, authorized or warranted to be suitable for use in life support, life-critical or safety-critical systems or equipment, nor in applications where failure or

malfunction of an NXP Semiconductors product can reasonably be expected to result in personal injury, death or severe property or environmental damage. NXP Semiconductors accepts no liability for inclusion and/or use of NXP Semiconductors products in such equipment or applications and therefore such inclusion and/or use is at the customer's own risk.

Applications — Applications that are described herein for any of these products are for illustrative purposes only. NXP Semiconductors makes no representation or warranty that such applications will be suitable for the specified use without further testing or modification.

Customers are responsible for the design and operation of their applications and products using NXP Semiconductors products, and NXP Semiconductors accepts no liability for any assistance with applications or customer product design. It is customer's sole responsibility to determine whether the NXP Semiconductors product is suitable and fit for the customer's applications and products planned, as well as for the planned application and use of customer's third party customer(s). Customers should provide appropriate design and operating safeguards to minimize the risks associated with their applications and products.

NXP Semiconductors does not accept any liability related to any default, damage, costs or problem which is based on any weakness or default in the customer's applications or products, or the application or use by customer's third party customer(s). Customer is responsible for doing all necessary testing for the customer's applications and products using NXP Semiconductors products in order to avoid a default of the applications and the products or of the application or use by customer's third party customer(s). NXP does not accept any liability in this respect.

Limiting values — Stress above one or more limiting values (as defined in the Absolute Maximum Ratings System of IEC 60134) will cause permanent damage to the device. Limiting values are stress ratings only and (proper) operation of the device at these or any other conditions above those given in the Recommended operating conditions section (if present) or the Characteristics sections of this document is not warranted. Constant or repeated exposure to limiting values will permanently and irreversibly affect the quality and reliability of the device.

Terms and conditions of commercial sale — NXP Semiconductors products are sold subject to the general terms and conditions of commercial sale, as published at <http://www.nxp.com/profile/terms>, unless otherwise agreed in a valid written individual agreement. In case an individual agreement is concluded only the terms and conditions of the respective agreement shall apply. NXP Semiconductors hereby expressly objects to applying the customer's general terms and conditions with regard to the purchase of NXP Semiconductors products by customer.

No offer to sell or license — Nothing in this document may be interpreted or construed as an offer to sell products that is open for acceptance or the grant, conveyance or implication of any license under any copyrights, patents or other industrial or intellectual property rights.

Export control — This document as well as the item(s) described herein may be subject to export control regulations. Export might require a prior authorization from national authorities.

Non-automotive qualified products — Unless this data sheet expressly states that this specific NXP Semiconductors product is automotive qualified, the product is not suitable for automotive use. It is neither qualified nor tested in accordance with automotive testing or application requirements. NXP Semiconductors accepts no liability for inclusion and/or use of non-automotive qualified products in automotive equipment or applications.

In the event that customer uses the product for design-in and use in automotive applications to automotive specifications and standards, customer (a) shall use the product without NXP Semiconductors' warranty of the product for such automotive applications, use and specifications, and (b) whenever customer uses the product for automotive applications beyond NXP Semiconductors' specifications such use shall be solely at customer's own risk, and (c) customer fully indemnifies NXP Semiconductors for any liability, damages or failed product claims resulting from customer design and use of the product for automotive applications beyond NXP Semiconductors' standard warranty and NXP Semiconductors' product specifications.

13. Contact information

For more information, please visit: <http://www.nxp.com>

For sales office addresses, please send an email to: salesaddresses@nxp.com

12.4 Licenses

ICs with DVB-T or DVB-T2 functionality

Use of this product in any manner that complies with the DVB-T or the DVB-T2 standard may require licenses under applicable patents of the DVB-T respectively the DVB-T2 patent portfolio, which license is available from Sisvel S.p.A., Via Sestriere 100, 10060 None (TO), Italy, and under applicable patents of other parties.

12.5 Trademarks

Notice: All referenced brands, product names, service names and trademarks are the property of their respective owners.

14. Contents

1	Product profile	1
1.1	General description	1
1.2	Features and benefits	1
1.3	Applications	2
2	Pinning information	2
3	Ordering information	2
4	Limiting values	2
5	Thermal characteristics	3
6	Characteristics	3
6.1	Ruggedness in class-AB operation	4
7	Application information	5
7.1	Narrowband RF figures	5
7.1.1	2-Tone	5
7.1.2	DVB-T	6
7.2	Broadband RF figures	6
7.2.1	2-Tone	6
7.2.2	DVB-T	7
7.3	Impedance information	7
7.4	Reliability	9
8	Test information	9
9	Package outline	13
10	Abbreviations	14
11	Revision history	14
12	Legal information	15
12.1	Data sheet status	15
12.2	Definitions	15
12.3	Disclaimers	15
12.4	Licenses	16
12.5	Trademarks	16
13	Contact information	16
14	Contents	17

Please be aware that important notices concerning this document and the product(s) described herein, have been included in section 'Legal information'.